

HYMAX[®] 2

(1.5" - 12")

HYMAX[®] 2 COUPLING AND LONG BODY COUPLING

HYMAX[®] 2 FLANGE ADAPTOR AND FLANGE ADAPTOR LONG BODY AND WITH NPT OUTLET

HYMAX[®] 2 REDUCER

HYMAX[®] 2 ELBOW 45° AND 90°

HYMAX[®] 2 THREADED OUTLET AND FLANGED OUTLET

HYMAX[®] 2 WITH CATHODIC PROTECTION



WARNING

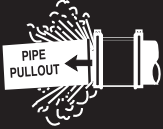

THIS PRODUCT DOES NOT RESTRAIN AXIAL PIPE MOVEMENT. PROPER ANCHORAGE OF THE PIPE IS REQUIRED IF THIS PRODUCT IS USED AS A COUPLING. FAILURE TO ANCHOR THE PIPE ENDS COULD RESULT IN THE ESCAPE OF LINE CONTENT, AND MAY CAUSE PROPERTY DAMAGE, SERIOUS INJURY OR DEATH.



CAUTION: THIS PRODUCT IS NOT INTENDED FOR USE ON NATURAL GAS PIPING, OR ANY OTHER TYPE OF GAS PIPING. THIS COULD RESULT IN ESCAPING GAS THAT COULD IGNITE AND CAUSE PROPERTY DAMAGE, SERIOUS INJURY OR DEATH.



IMPORTANT

THE HYMAX2 FLIP GASKET COUPLING is a wide-range coupling, featuring a patented flip gasket. Gasket can be easily opened by hand to accommodate larger OD pipes

THE HYMAX2 SERIES PRODUCTS ARE STAB-ON TYPE COUPLINGS. Do not disassemble the product. Do not lubricate nor loosen the bolts

DO NOT LUBRICATE BOLTS AND NUTS. Bolts are pre-lubricated with a MAG (Molecular anti-galling) coating. Greasing bolts or nuts voids manufacturer's warranty.

USE A TORQUE WRENCH TO TIGHTEN THE BOLTS. A torque wrench will assure a proper torque has been applied to the coupling. Do not use other tools to tighten the coupling's bolts!

LUBRICATION OF HYMAX Except steel, PVC, and PE pipes, all rough-surfaced pipes must be lubricated with a water-based gasket lubricant in order to achieve a proper seal.

TIGHTEN BOLTS TO THE TORQUE value provided on the label in one continuous step. Krausz Products do not require a gradual increase of torque over a specified period, nor do they require re-torque. The minimal torque requirements must be achieved prior to any recharging of the line.

PIPE STIFFENERS OR INSERTS are recommended when used on HDPE pipes.

PREPARE PRODUCT AND PIPE FOR INSTALLATION:

1

CLEAN AND DESCALE THE PIPE

Make sure that:

- The pipe is clear from debris.
- The pipe is not out of round and is free of scratches, dents, flats and defects
- The end rings are centered on the coupling - if they are not, please contact your local distributor for return and replacement

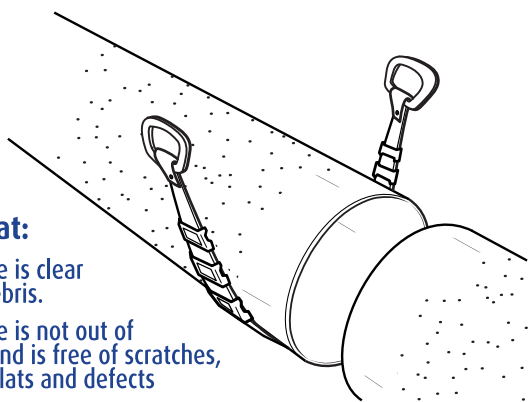

2

MEASURE THE PIPES' OD TWICE

RANGE

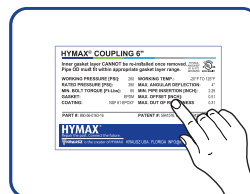

Make sure that:
the coupling size range (as indicated on the product's label) will fit the pipes properly

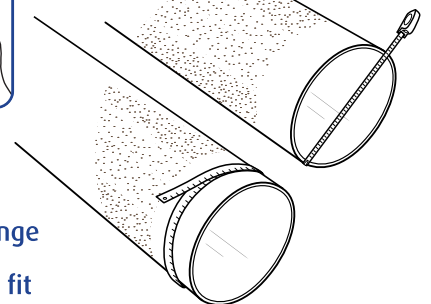

INSTALLATION OF THE COUPLING:

3

MARK EACH PIPE END FOR MINIMUM & MAXIMUM PIPE INSERTION DISTANCE

A,D Maximum stab depth for open gasket position
3.25" from the edge

B,C Minimum stab depth for closed gasket position
2.25" from the edge

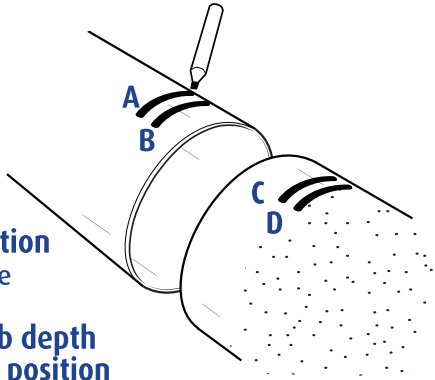

FOR SIZE 1.5" ONLY
use a lever (provided with product)
to flip the gasket out if wider pipe
diameter is required.

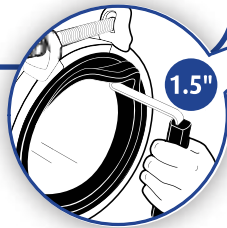

4

FLIP THE GASKET OPEN IF A LARGER OD IS REQUIRED

A
↓

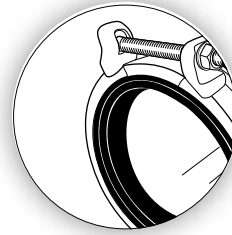

B
↓

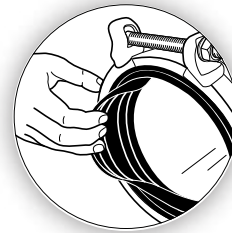

C

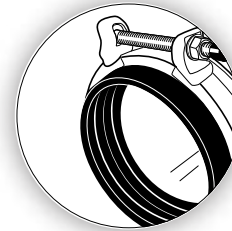

5

POSITION THE COUPLING FOR INSTALLATION

- If possible, place the coupling(s) on the replacement pipe (on both ends) with top-facing bolts and lower the pipe and couplings into the ditch

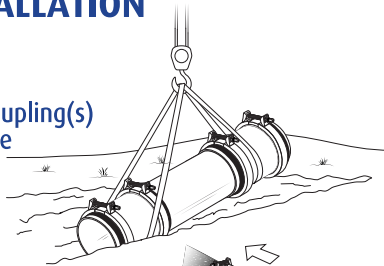

- Slide the couplings outward unto the pipes so that they cover the marks made in step 3

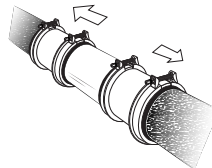

- Make sure that the pipes are not touching inside the body of the HYMAX. There must be space between the pipes in order for continuous dynamic deflection to take place

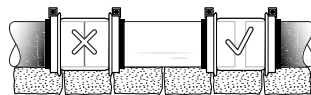

- Make sure that the pipes and the product are properly supported

- For Flange Adaptor: assemble the flange joint using flange bolts. Make sure you use a flat gasket between the flanges (not provided)

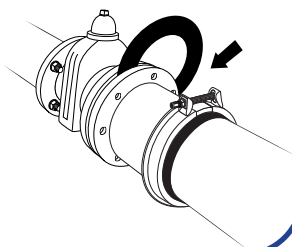

6

TIGHTEN BOLTS

TORQUE

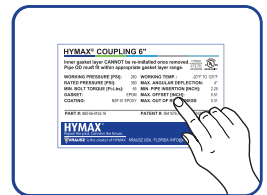
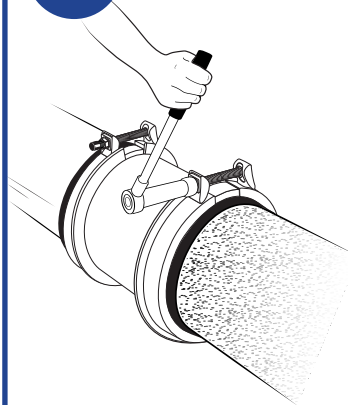

Tighten the coupling bolts to the right torque shown on the product label. When you finish, re-check the torque again

7

RECHARGE

Recharge the line and check for leaks. If any leakage is evident, reduce the pressure in the line and increase bolt torque up to 50%. Verify again there are no leaks along the seal

HYMAX[®]

Repair the past. Connect the future.

 **KRAUSZ** is the creator of HYMAX